

Model / Model

A145-315Nm 0630-1,60

Yük-Yolcu	/ Load-Person	630 Kg (8 Person)
Hız	/ Speed	1,6 m/s
Aski	/ Roping	2 / 1
Kasnak-Hatve	/ Sheave-Pitch	ø320 x 5 x ø8 / 14
V Kanal Açısı	/ V Groove Angle	40°
Enkoder	/ Encoder	Endat / Sincos / Biss-C
Fren	/ Brake Magnet	200 V DC
Duty Cycle	/ Görev Faktörü	S3 40%
Machine Weight	/ Makine Ağırlığı	195Kg
Maks. Statik Yük	/ Max. Static Load	4500Kg (2/1)
Tork	/ Torque	315 Nm
Bağlantı	/ Connect	(Δ) Delta
Devir	/ Motor RPM	190 RPM
Frekans	/ Frequency	50,67 Hz
Kutup Sayısı	/ Number of Poles	32 Poles
Motor Gücü	/ Motor Power	6,26 kW
Akım	/ Current	17,3 A
Voltaj	/ Terminal Voltage	317 V AC
Cosφ	/ Cos φ	0,84

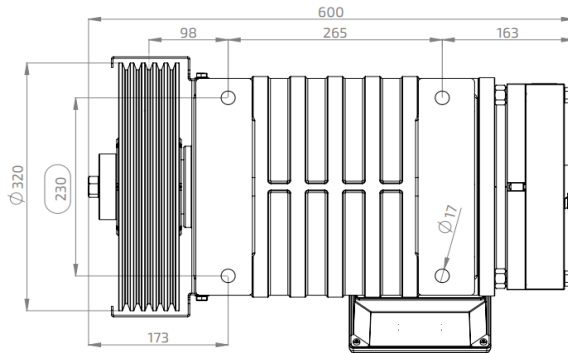
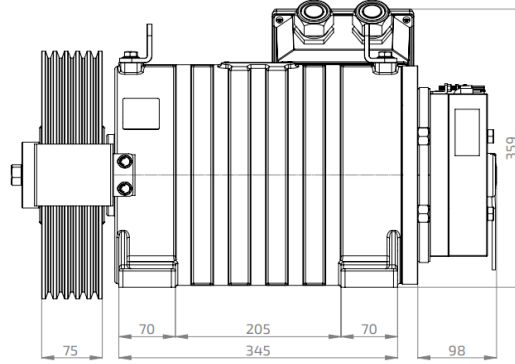
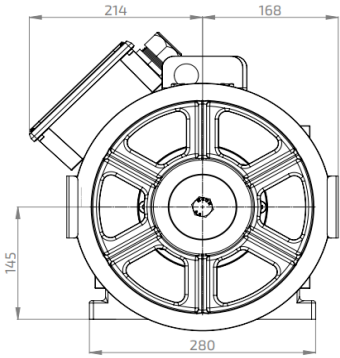

Astes Asansör ölçüler ve veriler üzerinde değişiklik yapma hakkına sahiptir.

The dimensions and data are subject to change without notice.