

Model / Model

A145-190Nm 0450-1,60

Yük-Yolcu	/ Load-Person	450 Kg (6 Person)
Hız	/ Speed	1,6 m/s
Aski	/ Roping	2 / 1
Kasnak-Hatve	/ Sheave-Pitch	ø240 x 5 x ø6,5 / 12
V Kanal Açısı	/ V Groove Angle	45°
Enkoder	/ Encoder	Endat / Sincos / Biss-C
Fren	/ Brake Magnet	200 V DC
Duty Cycle	/ Görev Faktörü	53 40%
Machine Weight	/ Makine Ağırlığı	150Kg
Maks. Statik Yük	/ Max. Static Load	4500Kg (2/1)
Tork	/ Torque	190 Nm
Bağlantı	/ Connect	(Δ) Delta
Devir	/ Motor RPM	255 RPM
Frekans	/ Frequency	68 Hz
Kutup Sayısı	/ Number of Poles	32 Poles
Motor Gücü	/ Motor Power	5,07 kW
Akım	/ Current	16,1 A
Voltaj	/ Terminal Voltage	288 V AC
Cosφ	/ Cos φ	0,82

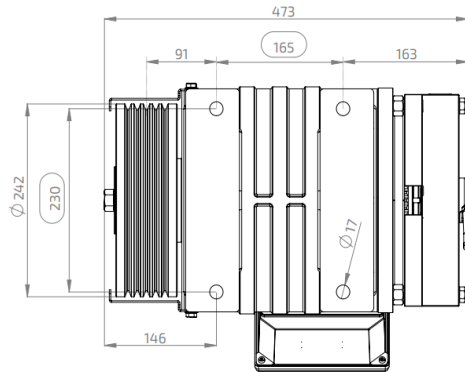
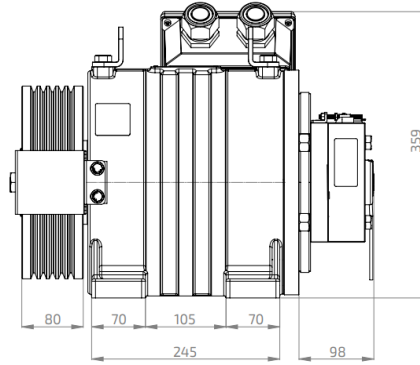
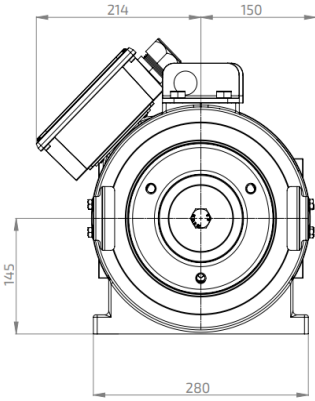

Astes Asansör ölçüler ve veriler üzerinde değişiklik yapma hakkına sahiptir.

The dimensions and data are subject to change without notice.